

### 3 Port Miniature Solenoid Valve Series DR100

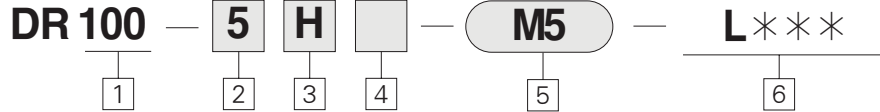

- Low power consumption / 0.6WDC
- Compact design
- Large flow capacity  
0.17mm<sup>2</sup>(Cv0.009)

### How to Order



- Series DR100 – N/C  
Series DR120 – N/O  
Miniature(10mm Width) Valve
- 1 Configuration**  
100 : Normal Closed(N/C)  
120 : Normal Open(N/O)
- 2 Voltage**  
5 : DC24V  
6 : DC12V
- 3 LEAD Electrical Entry(DC,AC)**  
H : Horizontal Connector Type
- 4 PCB Type**  
Blank : Standard Type  
D : Nonpolar Lamp Type  
S : Power Saving PCB Type (0.85→0.45W)  
D.S only used in V.H Type
- 5 Option(Subplate)**  
Blank : Without Subplate  
M5 : With Subplate (M5×0.8)  
※ It is standard to attach the
- LAMP/SURGE voltage protection circuit. (Products without a LAMP or SURGE voltage protection circuit should be contacted separately)
- 6 Length of lead wire**  
Blank : 300mm(Standard)  
L01: 100mm  
L02: 200mm  
:  
:  
:  
L20: 2000mm  
∴ Other length : Contact us

### Specifications

DV Series	DR100	DR120	
Fluid	Air		
Operating Pressure Range · MPa(PSI)	0~0.7MPa(0~102PSI)		
Acting	N.C	N.O	
Ambient and Fluid Temperature · °C(°F)	5~50°C(41~122°F)		
Voltage Allowance (%)	-10~+10 of Rated Voltage		
Maximum Operation Frequency(C/S)	10		
Minimum Operation Frequency	30days per one session (Only in the case of a KS B 6356)		
Lubrication	Not Required(ISO VG32)		
Impact / Vibration Resistance (m/s <sup>2</sup> )	30G / 5G		
Mounting Position	Free		
Manual Override	Non Locking Push Type		
LEAD Electrical Entry	Horizontal(H), Vertical(V)		
Indicator light and Surge Voltage Suppressor	LED/Surge Voltage Suppressor Standard		
Voltage (V)	DC24, DC12V		
Effective Area mm <sup>2</sup> ( l /min)	Input(P→A):0.28(18) ↑	Output(A→R):0.3(20) ↑	
Power Consumption (W)	DC (W)	24V	0.6(with LAMP)
	12V	1.0(with LAMP)	
Response Time/ms	10ms or less (At 5kgf/cm <sup>2</sup> , on Time)		
Color	White	Gray	

### Model

Model	Actuation	Port size	Effective Orifice mm <sup>2</sup> (Cv Factor)
DR100-5(H,V)-**	NORMAL CLOSE (NC)	M5X0.8	0.17(0.009)
DR120-5(H,V)-**	NORMAL OPEN (NO)	M5X0.8	0.14(0.008)

### Manifold

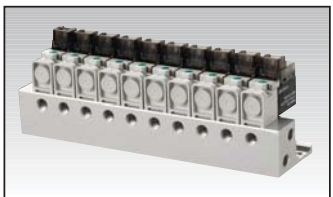

### How to Order

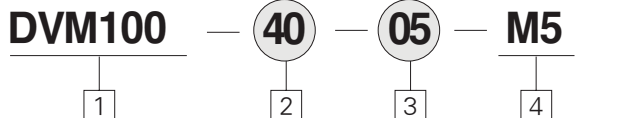

- 1 Series DR100 Manifold**  
10mm Body Size Valve
- 2 Manifold Specifications**  
40 : Base Mounted
- 3 Stations**  
01 : 1Station  
02 : 2Stations  
03 : 3Stations  
∴  
10 : 10Stations
- 4 Port Size**  
M5 : M5×0.8 Basic

## Plug-In Type 5port Pilot Solenoid Valve Series RS

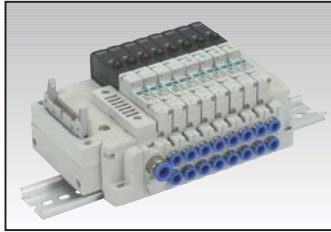

- 2 Mounting options available (din rail or tie-rod)
- Multiple supply blocks adaptable
- Expandable to 24 single stations
- Single, double, 3 position and dual operation 3 port 4 position options available.
- Electrical input, d-sub, flat cable connector: for use with serial interface

### Specifications—Solenoid Valve

Fluid		Air	
Operating Pressure Range MPa(kgf/cm <sup>2</sup> )	Internal Pilot	2 Position Single	0.15~0.7 (1.5~7.1)
		2 Position Double	0.1~0.7 (1~7.1)
		3 Position	0.2~0.7(2~7.1)
		4 Position Dual 3 Port	0.15~0.7(2~7.1)
	External Pilot	Operating Pressure Range	-100kPa~0.7MPa
		Pilot Pressure	0.25~0.7
Ambient and Fluid temperature(°C)		0 ~ 50(32~122°F)	
Manual Override		Non Lock Push Type	
Pilot Exhaust	Internal Pilot	Common Exhaust for Main Valve & Pilot Valve	
	External Pilot	Individual Exhaust	
Lubrication		None	
Mounting		Free	
Impact/Vibration Resistance %		150/30	
Max. Operating Frequency(Hz)	2 Position, 4 Position		5
	3 Position		3
Enclosure		IP40	
Coil Voltage(V)		DC 24, DC 12	
Allowable Voltage(%)		-10~+10% of Rated voltage	
Polar		Nonpolar	
Power Consumption(W)		0.85 (with Lamp, Surge)	

### Specifications—Manifold

		RS1000	RS2000
Type of Mounting		Din Rail, Tie Rod	
Supply & Exhaust		Common Supply and Exhaust	
Max. Stations		24	
Number of Output		24	
Port Size	P, R	Ø8, Ø5/16"	Ø10, Ø3/8"
	A, B	Ø4, Ø6, Ø5/32", Ø1/4"	Ø4, Ø6, Ø8, Ø5/32", Ø1/4", Ø5/16"

### Flow Characteristics

Series		Valve Description	Pipe	Combined Orifice mm <sup>2</sup> (Cv)
BASE Ported	RS1140	Single Solenoid	Ø6	4.0(0.22)
	RS1240	Double Solenoid	Ø6	4.0(0.22)
	RS1340	Closed Center	Ø6	3.3(0.18)
	RS1440	Exhaust Center	Ø6	3.3(0.18)
	RS1540	Pressure Center	Ø6	4.9(0.27)
	RS1640	4 Position N.C/N.C	Ø6	3.3(0.18)
	RS1740	4 Position N.O/N.O	Ø6	3.3(0.18)
	RS1840	4 Position N.C/N.O	Ø6	3.3(0.18)

### Response Time

Type	Response Time(ms)
2 Position Single	12 or less
2 Position Double	11 or less
3 Position	18 or less
4 Position Dual 3 Port	16 or less

ACP/  
UACP  
APM  
AS  
AX  
AM  
AM2  
AL/  
ALX  
AQ/  
UAQ  
ADQCP  
AQ2/  
UADQ2  
AG/  
UAG  
NGQ/  
UNGG  
AJ/  
AJM  
ABK  
NSK  
GX/  
AGX  
NDM  
ADR  
AMR/  
UAMR  
NST  
AST  
ASTH  
NF  
NLCD  
NLCS  
TCRL  
NP  
ARD/  
UARD  
NR  
ASL  
SB  
SAH  
CR/  
CV  
CR/  
CV-AQ2,ADQ2  
CR/  
CV-AX  
CR/  
CV-NLCD  
CR/  
CV-AGL  
DR100  
RS  
DV1000/  
3000/4000  
DS300  
DS2000

## Plug-In Valve Model Number System

### 1) Valve Type Indication Method

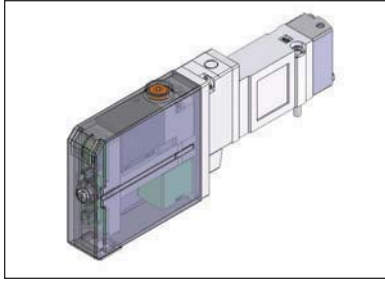

**RS** 1 1 **40**   - 5 -    
1 2 3 4 5

- 1 Series**  
 1 : RS1000  
 \* 2 : RS2000  
 ※Inquire Separately

- 2 Transfer Type**  
 1 : 2 Position Single  
 2 : 2 Position Double  
 3 : 3 Position Closed Center  
 4 : 3 Position Exhaust Center  
 5 : 3 Position Pressure Center  
 6 : 4 Position Dual 3-Port:NC, NC  
 7 : 4 Position Dual 3-Port:NO, NO  
 8 : 4 Position Dual 3-Port:NC, NO

- 3 Pilot Specifications**  
**No Symbol** : Internal Pilot  
**P** : External Pilot  
 Note) 4 Position Dual 3 Port Valves are not connected to external pilot.

1		5	
2		6	
3		7	
4		8	

- 4 Rated Voltage**  
 5 : DC 24V  
 6 : DC 12V
- 5 Manifold Option**  
**Blank** : Manifold unattached  
**WM** : Manifold attached

### 2) Manifold Assembly Type Indication Method

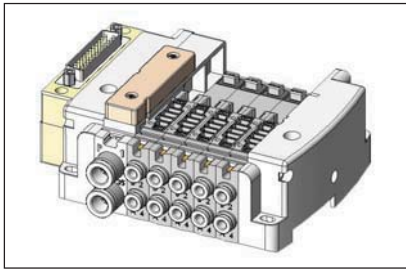

**RSM** 1 - DR D V - 05 B   - T6  
1 2 3 4 5 6 7 8

- 1 Series**  
 1 : RS1000  
 \* 2 : RS2000  
 ※Inquire Separately
- 2 Block Connection**  
**DR** : Din Rail Connection(2~24 Station)  
**TR** : Tie Rod Connection(11~24 Station)  
**DT** : Combination of Din Rail & Tie Rod(11~24 Station)

- 3 Connector Type**  
**D** : D-sub Connector(25Pin)  
**F** : Flat Cable Connector(26Pin)

- 4 Connector Pulling**  
**V** : Vertical  
**H** : Horizontal

- 5 Valve Connection**

02	St,2	Double Wiring
↓	↓	
12	St,12	Arrangement
↓	↓	
02	St,2	Arrangement
↓	↓	
24	St,24	Arrangement
↓	↓	

- 6 P, E Port Pulling Direction**

B (2~10 Station)	
T (2~10 Station)	
A (11~24 Station)	

- 7 Pilot Specifications**

No Symbol	Internal Pilot	
N	Internal Pilot With Noise Reducer	
P	External Pilot	
PN	External Pilot With Noise Reducer	

- 8 Pipe Diameter**

(mm)			
Symbol	A,B Ports	P,E Ports	Series
T4	∅4	∅8	RS1000
T6	∅6		
T4	∅4	∅10	RS2000
T6	∅6		
T8	∅8		

(Inch)			
Symbol	A,B Ports	P,E Ports	Series
U4	∅5/32"	∅5/16"	RS1000
U6	∅1/4"		
U4	∅5/32"	∅3/8"	RS2000
U6	∅1/4"		
U8	∅5/16"		

## 5 Port pilot solenoid valve Series DV1000 · 3000 · 4000

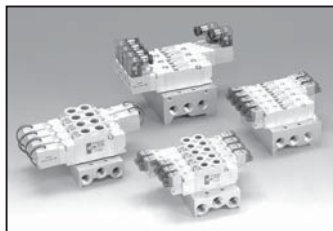

- Quick response time & large flow capacity
  - Low consumer electric power 0.6W (24VDC, 25mA)
- High Reliability
  - Long life
- Product diversity
  - Easy wiring
  - Nickel plated(copper free)
  - Built-in LED for grommet type

### How to Order

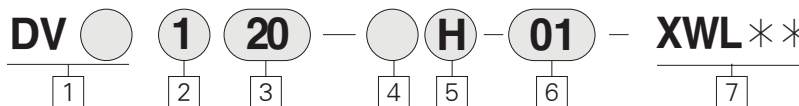

- [1] DV Valve Series**  
 1 : DV1000 Series  
 3 : DV3000 Series  
 4 : DV4000 Series
- [2] Configuration**  
 1 : Single Solenoid  
 2 : Double Solenoid  
 3 : Closed Center  
 4 : Exhaust Center  
 5 : Pressure Center
- [3] Manifold Specification**  
 20 : Body Ported  
 40 : Base Mounted
- [4] Voltage**  
 1 : AC110V  
 2 : AC220V  
 5 : DC24V  
 6 : DC12V

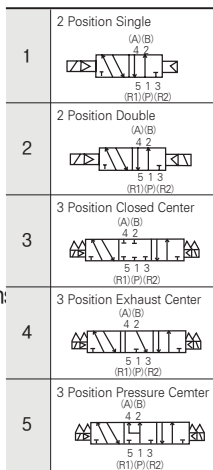

- [5] Electrical Entry**  
 H : Horizontal connector(DC12,24)  
 V : Vertical connector(DC12,24,AC110)  
 G : Grommet Type(Basic option Lamp)  
 D : Din Terminal Type(DC24) (Without Lamp)  
 DZ : Din terminal Type(DC24) (With Lamp)  
 \* G,D,DZ types are enable DV3000, DV4000 series only.
- [6] Port Size**  
 Blank : Without Sub Plate  
 M5 : M5×0.8 (DV1000 Series)  
 01 : Rc(PT)1/8 (DV3000 Series)  
 02 : Rc(PT)1/4 (DV4000 Series)  
 \* When using the TPC valve be sure to use the TPC gasket.

- \* It is standard to attach the LAMP/SURGE voltage protection circuit. (Products without a LAMP or SURGE voltage protection circuit should be contacted separately)
- [7] Length of lead wire**  
 Blank : 300mm (Standard)  
 XWL01 : 100mm  
 XWL02 : 200mm  
 :  
 :  
 XWL20 : 2000mm  
 ∴ Other length : Contact us

### How to Order

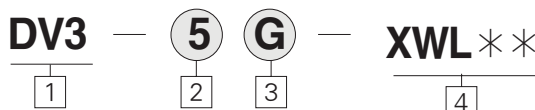

- [1] DV Series Pilot Valve Ass'y**
- [2] Configuration**  
 1 : AC110V  
 2 : AC220V  
 5 : DC24V

- [3] LEAD Electrical Entry**  
 G : Grommet type(Basic Option Lamp)  
 D : Din Terminal type(Without Lamp)  
 DZ : Din Terminal type(With Lamp)

- [4] Length of lead wire**  
 Blank : 300mm (Standard)

- XWL01 : 100mm  
 XWL02 : 200mm  
 :  
 :  
 XWL20 : 2000mm  
 ∴ Other length : Contact us

### Manifold

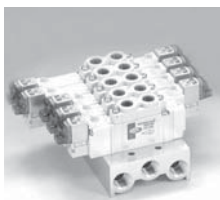

Body ported(Connector type)



Base mounted(Grommet type)

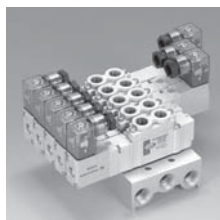

Body ported(Terminal type)

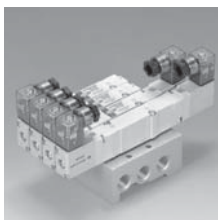

Base mounted(Terminal type)

### Specifications

Series	DV1000	DV3000	DV4000		
Acting	5 Port Pilot Type Solenoid Valve(Rubber Seal)				
Fluid	Air				
Operating Pressure Range	2Position Single	0.15~0.7MPa(20~100psi)			
	2Position Double	0.1~0.7MPa(14~100psi)			
	3 Position	0.2~0.7MPa(27~100psi)			
Ambient and Fluid Temperature(°F)	MAX. 50°C(122°F)				
Manual Override	Push&Lock Type				
Pilot Exhaust Type	Ambient, Collection Exhaust Type				
Lubrication	Not Required				
Mounting Position	Free				
Impact/Vibration Resistance(%)	H,V	150/30(8.3~2000Hz)			
	G,D,DZ	300/50			
Max. Operating Frequency	2Position	10	5		
	3 Position	3	3	3	
Protection Structure	Dust Proof(DIN connector1965)				
Lead Electrical Entry	Connector Mounting Type H:Horizontal,V:Vertical), Grommet, Din Terminal Type				
Voltage	DC12, DC24V, AC110V, AC220V				
Voltage Allowance	-10(%)~+10(%)of Rated Voltage				
Polarity	Non-polar (standard)				
Response Time(ms)	at 5kgf/cm <sup>2</sup> (71.1psi)	H,V	~12ms	~18ms	~30ms
		G,D,DZ	-	~26ms	~38ms
Power Consumption(W)	G,D,DZ	H,V	1.0(*DC24V:0.6)(Indicator Light and Surge suppressor)		
			With Lamp(1.6) Without Lamp(1.8)		
Effective Orifice	Single	3.6mm <sup>2</sup> (Cv0.2)	9.0mm <sup>2</sup> (Cv0.5)	16.2mm <sup>2</sup> (Cv0.9)	

- ACP/ UACP
- APM
- AS
- AX
- AM
- AM2
- AL/ ALX
- AQ/ UAQ
- ADQCP
- AQ2/ UADQ2
- AG/ UAG
- NGQ/ UNGQ
- AJ/ AJM
- ABK
- NSK
- GX/ AGX
- NDM
- ADR
- AMR/ UAMR
- NST
- AST
- ASTH
- NF
- NLCD
- NLCS
- TCRL
- NP
- ARD/ UARD
- NR
- ASL
- SB
- SAH
- CR/ CV
- CR/ CV-AQ2,ADQ2
- CR/ CV-AX
- CR/ CV-NLCD
- CR/ CV-AGL
- DR100
- RS
- DV1000/ 3000/4000
- DS300
- DS2000

## 3 Port Solenoid Valve Series DS300

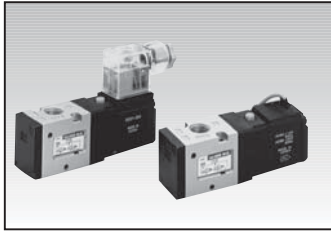

- Compact size and light weight
- Large flow capacity/Cv0.9
- Low power consumption/1.8WDC
- Designed for non-lubricated service
- Easy modification of N · C to N · O

< Symbol >

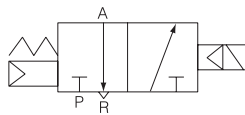

DS 301 Normally Closed

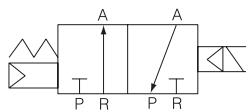

DS 301 Normally Open

Body Ported Type	Model	Port Size	Position	Solenoid	Effective Orifice mm <sup>2</sup> (Cv)	Pressure kgf/cm <sup>2</sup> (psi)
3 Port	DS301	Rc(PT)1/8, 1/4	2	Single	1/8:19.2(1.07)	1.5~9(21~128)
	UDS301	NPT1/8, 1/4			1/4:22(1.2)	

※ AType : Normally Closed, BType : Normally Open

### How to Order

- Valve **U** **DS3** **0** **1** - **1** **G** **C** - **02** **A** - **XWL** \*\*

**1** Series

Blank : Metric Rc(PT)  
U : NPT

**2** Type of Actuation

0 : Normal Closed/Normal Open

**3** Body Option

1 : Body Ported Type

**4** Voltage

1 : AC110V, 50/60Hz  
2 : AC220V, 50/60Hz  
3 : AC120V, 50/60Hz  
4 : AC240V, 50/60Hz  
5 : DC24V  
6 : DC12V  
7 : DC6V  
8 : Other(ex AC24V)  
9 : DC100V

**5** Electronic Entry/Indicator

Light and Surge Suppressor  
G : Grommet  
(Lead wire length 300mm)  
DZ : With Indicator light and Surge Suppressor  
N : W/D DIN connector

**6** Manual Override

Blank : Non-locking PushType  
C : Knob locking Type

**7** Port Size (P, A, R Port)

01 : 1/8  
02 : 1/4(Standard)

**8** Type of Actuation

A : Normally Closed  
B : Normally Open

**9** Special Option

Blank : Standard Type  
XC16 : Copper-Free

**10** Length of lead wire

Blank : 300mm  
(Standard)  
XWL01 : 100mm  
XWL02 : 200mm  
:  
:  
XWL20 : 2000mm  
∴ Other length : Contact us

- Pilot Valve Assembly **SC2** - **1** **G** - **50** - **XWL** \*\*

**1** Voltage

1 : AC100V, 50/60Hz  
2 : AC200V, 50/60Hz  
3 : AC120V, 50/60Hz  
4 : AC240V, 50/60Hz  
5 : DC24V  
6 : DC12V  
7 : DC6V  
8 : Other(ex AC24V)  
9 : DC100V

**2** Electrical Entry/Indicator

Light and Surge Suppressor  
G : Grommet (Lead wire length 300mm)  
DZ : DIN Connector With Indicator light and Surge suppressor  
D : DIN Terminal Type

**3** Manual override

Blank : Non-locking Push type  
C : Knob locking type

**4** Special Option

Blank : Standard type  
XC16 : Copper-free

**5** Length of lead wire

Blank : 300mm(Standard)  
XWL01 : 100mm  
XWL02 : 200mm  
:  
:  
XWL20 : 2000mm  
∴ Other length : Contact us

### Specifications

Models	DS300	
Action	Pilot Type	
Position, Port	2 Position, 3 Port	
Body Options	Body Ported Type	
Fluid	Air	
Port Size Rc(PT)	1/8"	1/4"
Effective Orifice mm <sup>2</sup> (Cv)	19.2 (1.07)	22 (1.2)
Operating Pressure Range	1.5~9kgf/cm <sup>2</sup> (21~128psi)	
Ambient and Fluid Temperature	Max. 50 °C (122 °F)	
Response Time	30ms or Less ( 5kgf/cm <sup>2</sup> (7.1psi))	
Max. Operating Frequency	5c/s	
Lubrication	Not Required	
Manual Override	Non-Lock Push Type, Knob Locking Type	
Mounting Position	Free	
Impact/Vibration Resistance	30 G/5 G (8.3~2000 Hz)	

# 5 Port Solenoid Valve Series DS2000

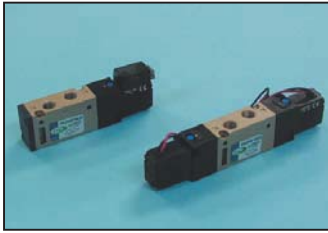

- Compact size and light weight - 18mm width
- Large flow capacity / Cv 0.53
- Low power consumption / 1.7W(DC)
- Many variations available

< Symbol >

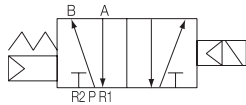

Single : DS 2120

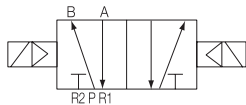

Double : DS 2220

Body Ported Type	Model	Port Size		Position	Solenoid	Effective Orifice mm <sup>2</sup> (Cv)	Pressure kgf/cm <sup>2</sup> (psi)
		DS	UDS				
5 Port	DS2120	Rc(PT)1/8	NPT1/8	2	Single	9.5(0.53)	1.8~7(25~100)
	DS2220				Double		

## How to Order

- Valve **DS 2** **1** **2** **0** - **1** **G** - **01** - **XWL** \* \*

**1** Series  
Blank : Metric Rc(PT)  
U : NPT

**2** Type of Actuation  
1 : 2 Position Single  
2 : 2 Position Double

**3** Body Type  
2 : Body Ported Type

**4** Voltage  
1 : AC 110V(50/60Hz)  
2 : AC 220V(50/60Hz)  
3 : AC 120V(50/60Hz)

**5** Electrical Entry/Indicator Light and Surge Suppression  
4 : 240V  
5 : DC 24V  
6 : DC 12V  
※ 3,4 : Non-Standard.  
G : Grommet  
H : Plug Connector Type (Horizontal type, with Indicator light)  
HZ: Plug Connector Type(with Indicator Light and Surge Voltage Suppressor)  
※ Plug Connector Type of DC has only HZ type

**6** Port Size  
01 : 1/8  
**7** Length of lead wire  
Blank : 300mm (Standard)  
XWL01 : 100mm  
XWL02 : 200mm  
∴ Other length : Contact us

- Manifold Base

**DSM2** - **20** - **05** **1**

**1** Series  
Blank : Metric (PT)  
U : NPT Manifold for Series UDS2000

**2** 20  
Manifold Specifications

**3** Stations 03 stations  
01 stations ∴  
02 stations 20 stations

## Standard/Specifications

		DS2120/UDS2120	DS2220/UDS2220
Fluid		Air	
Operating Pressure Range		1.5~7kgf/cm <sup>2</sup> (25~100psi)	1~7kgf/cm <sup>2</sup> (14~100psi)
Effective Orifice (mm <sup>2</sup> )(Cv)		9.5(0.53)	
Ambient and Fluid Temperature		Max. 50°C (122 °F)	
Response Time(5kgf/cm <sup>2</sup> )		20ms or Less	
Max. Operating Frequency		10c/s	
Lubrication		Not Required	
Manual Override		Non-Locking Push Type	
Impact/Vibration Resistance		30G/5G(8.3~2000HZ)	
Enclosure		Dust Proof	
Coil Voltage		AC 50/60HZ 110V, 220V, DC12V, 24V	
Allowable Voltage		-15%~ +10% of Rated Voltage	
Coil Insulation		Class B or Equivalent(130°C)	
Power Consumption	AC	Starting	4.5VA(50HZ), 4.2VA(60HZ)
		Holding	3.0VA(50HZ), 2.6VA(60HZ)
	DC	1.7W	
Weight · gf ( l b )		100(0.22 l b)	150(0.33 l b)
Surge Suppressor Circuit		AC:Varistor , DC:Diode	
Indicator Light		LED	

- ACP/ UACP
- APM
- AS
- AX
- AM
- AM2
- AL/ ALX
- AQ/ UAQ
- ADQCP
- AQ2/ UADQ2
- AG/ UAG
- NGQ/ UNGQ
- AJ/ AJM
- ABK
- NSK
- GX/ AGX
- NDM
- ADR
- AMR/ UAMR
- NST
- AST
- ASTH
- NF
- NLCD
- NLCS
- TCRL
- NP
- ARD/ UARD
- NR
- ASL
- SB
- SAH
- CR/ CV
- CR/ CV-AQ2,ADQ2
- CR/ CV-AX
- CR/ CV-NLCD
- CR/ CV-AGL
- DR100
- RS
- DV1000/ 3000/4000
- DS300 DS2000

## 5 Port Pilot Solenoid Valve Series DS3000

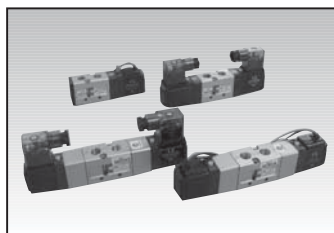

- Compact size and light weight
- Large flow capacity
- Low power consumption
- Designed for non-lubricated service

Body Ported Type	Model	Port Size		Position	Solenoid	Effective Orifice mm <sup>2</sup> (Cv)		Pressure kgf/cm <sup>2</sup> (psi)
		DS	UDS			1/8	1/4	
5 Port	DS3130	RC(PT) 1/8	NPT 1/8	2	Single	14.4(0.8)	18(1.0)	1.5~9(21~128)
	Double				14.4(0.8)	18(1.0)	1~9(14~128)	
	DS3330	1/4	1/4	3	Closed Center	11.7(0.65)	14.4(0.8)	1.5~9(21~128)
	DS3430				Exhaust Center	14.4(0.8)	18(1.0)	

### How to Order

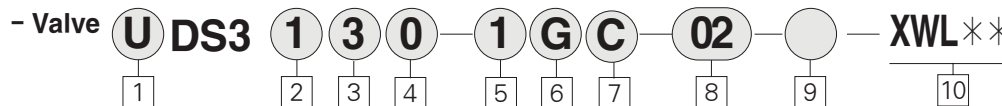

- |                                                                                                                                                                                                                                                                                                                                                                                                                                                               |                                                                                                                                                                                                                                                                                                                                                                       |                                                                                                                                                                                                                                                                                                                                                                                                                           |
|---------------------------------------------------------------------------------------------------------------------------------------------------------------------------------------------------------------------------------------------------------------------------------------------------------------------------------------------------------------------------------------------------------------------------------------------------------------|-----------------------------------------------------------------------------------------------------------------------------------------------------------------------------------------------------------------------------------------------------------------------------------------------------------------------------------------------------------------------|---------------------------------------------------------------------------------------------------------------------------------------------------------------------------------------------------------------------------------------------------------------------------------------------------------------------------------------------------------------------------------------------------------------------------|
| <p><b>1 Series DS3000</b><br/>Blank : Metric Rc(PT)<br/>U : NPT</p> <p><b>2 Type of Actuation</b><br/>1 : 2 Position/Single Solenoid<br/>2 : 2 Position/Double Solenoid<br/>3 : 3 Position/Closed Center<br/>4 : 3 Position/Exhaust Center</p> <p><b>3 Body Option</b><br/>3 : for 30 type Manifold. Body Ported</p> <p><b>4 Voltage</b><br/>0 : Standard<br/>3 : Common Exhaust for main and Pilot Valve</p> <p><b>5 Voltage</b><br/>1 : AC110V, 50/60Hz</p> | <p>2 : AC220V, 50/60Hz<br/>3 : AC120V, 50/60Hz<br/>4 : AC240V, 50/60Hz<br/>5 : DC24V<br/>6 : DC12V<br/>7 : DC6V<br/>8 : Other<br/>9 : DC100V</p> <p><b>6 Electronic Entry/Indicator</b><br/>Light and Surge Suppressor<br/>G : Grommet<br/>(Lead Wire Length 300mm)<br/>D : DIN Terminal Type</p> <p>DZ : DIN Connector with Indicator Light and Surge Suppressor</p> | <p><b>7 Manual Override</b><br/>Blank : Non-Locking PushType<br/>C : Knob Locking Type</p> <p><b>8 Port Size</b><br/>01 : 1/8<br/>02 : 1/4(Exhaust Port:1/8)</p> <p><b>9 Special Option</b><br/>Blank : Standard Type<br/>XC16 : Copper-Free</p> <p><b>10 Length of lead wire</b><br/>Blank : 300mm<br/>(Standard)<br/>XWL01 : 100mm<br/>XWL02 : 200mm<br/>:<br/>:<br/>XWL20 : 2000mm<br/>∴ Other length : Contact us</p> |
|---------------------------------------------------------------------------------------------------------------------------------------------------------------------------------------------------------------------------------------------------------------------------------------------------------------------------------------------------------------------------------------------------------------------------------------------------------------|-----------------------------------------------------------------------------------------------------------------------------------------------------------------------------------------------------------------------------------------------------------------------------------------------------------------------------------------------------------------------|---------------------------------------------------------------------------------------------------------------------------------------------------------------------------------------------------------------------------------------------------------------------------------------------------------------------------------------------------------------------------------------------------------------------------|

< Symbol >

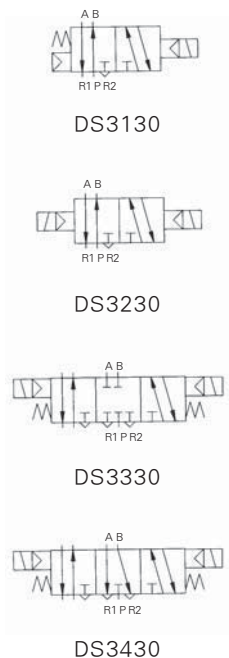

- |                                                                                                        |                                                                               |
|--------------------------------------------------------------------------------------------------------|-------------------------------------------------------------------------------|
| <p><b>1 Manifold for DS3000 series</b><br/>Blank : Metric Rc(PT)<br/>U : NPT<br/>- Port Size : 1/4</p> | <p><b>2 Stations</b><br/>02 : 2 stations<br/>:<br/>:<br/>20 : 20 stations</p> |
|--------------------------------------------------------------------------------------------------------|-------------------------------------------------------------------------------|

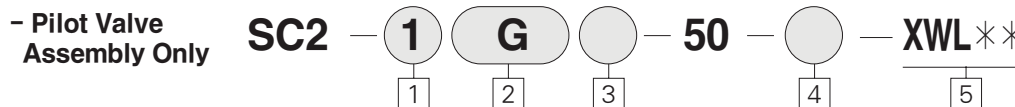

- |                                                                                                                                                                                                                                                                     |                                                                                                                                                                                                                                                                                                                    |                                                                                                                                                                         |
|---------------------------------------------------------------------------------------------------------------------------------------------------------------------------------------------------------------------------------------------------------------------|--------------------------------------------------------------------------------------------------------------------------------------------------------------------------------------------------------------------------------------------------------------------------------------------------------------------|-------------------------------------------------------------------------------------------------------------------------------------------------------------------------|
| <p><b>1 Voltage</b><br/>1 : AC110V, 50/60Hz<br/>2 : AC220V, 50/60Hz<br/>3 : AC120V, 50/60Hz<br/>4 : AC240V, 50/60Hz<br/>5 : DC24V<br/>6 : DC12V<br/>7 : DC6V<br/>8 : Other<br/>9 : DC100V</p> <p><b>2 Electrical Entry/Indicator Light and Surge Suppressor</b></p> | <p>G : Grommet (Lead Wire Length 300mm)<br/>DZ : DIN Connector with Indicator Light and Surge Suppressor<br/>D : DIN Terminal Type</p> <p><b>3 Manual override</b><br/>Blank : Non-Locking Push Type<br/>C : Knob Locking Type</p> <p><b>4 Special Option</b><br/>Blank : Standard Type<br/>XC16 : Copper-Free</p> | <p><b>5 Length of lead wire</b><br/>Blank : 300mm<br/>(Standard)<br/>XWL01 : 100mm<br/>XWL02 : 200mm<br/>:<br/>:<br/>XWL20 : 2000mm<br/>∴ Other length : Contact us</p> |
|---------------------------------------------------------------------------------------------------------------------------------------------------------------------------------------------------------------------------------------------------------------------|--------------------------------------------------------------------------------------------------------------------------------------------------------------------------------------------------------------------------------------------------------------------------------------------------------------------|-------------------------------------------------------------------------------------------------------------------------------------------------------------------------|

DS3000  
DS5000  
DP300/  
3000/5000  
DS6000  
DS3000  
(Base Ported)  
DX1,2  
DX2R  
DH  
DW  
DM  
DT220/  
UDT220/DC  
TPC-1000  
/1200  
PC  
PF  
PR  
PL  
PP  
PFH/  
PFU  
PLV  
TXF  
PVR/PNR  
PER2000  
/3000  
TAD  
EP  
EM/EL  
SPSA  
SPS  
SQ  
SC  
SP  
SP4000  
/SPM  
SP2000  
SN  
SQ2  
SH  
DCH  
SF  
ST  
W1  
W2/W3  
W4/W5  
W6/W7  
Mini  
Auto Switch

Specifications		
Fluid	Air	
Operating Pressure Range	2 Position Single · 3 Position	1.5~9 kgf/cm <sup>2</sup> (21~128 psi)
	2 Position Double	1~9 kgf/cm <sup>2</sup> (14~128 psi)
Ambient and Fluid Temperature	50°C (122 °F)	
Response Time	2 Position Single/Double	30 ms or Less {5kgf/cm <sup>2</sup> (71 psi)}
	3 Position	40 ms or Less {5kgf/cm <sup>2</sup> (71 psi)}
Max. Operating Frequency	2 Position Single/Double	5c/s
	3 Position	3c/s
Lubrication	Not Required※	
Manual Override	Non-locking Push Type, Knob Locking Type	
Mounting Position	Free	
Impact/Vibration Resistance	30 G/5 G(8.3~2000 Hz)	
Enclosure	Dust Proof	
Pilot Exhaust	Individual Exhaust, Common Exhaust for Main Valve and Pilot Valve	

※ If provided, use Turbine 0.1(ISO VG #32)

Electrical Entry	Grommet, DIN Connector		
Coil Voltages	AC 50/60Hz	110VAC, 220VAC, 120VAC, 240VAC	
	DC	6VDC, 12VDC, 24VDC	
Allowable Voltage	-15~+10% of rated voltage		
Power Consumption	AC	Inrush	5.6VA(50Hz), 5.0VA(60Hz)
		Holding	3.4VA(50Hz), 2.3VA(60Hz)
	DC	1.8W/2W(With LED)	
Indicator Light/Surge	AC	LED, Varistor	
Suppressor Circuit	DC	LED, Varistor	

## DSM3 / Manifold

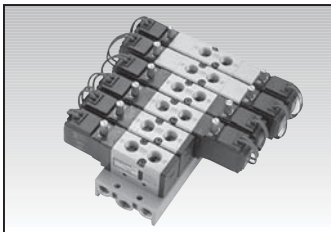

Model for Manifold			
Model	Manifold		
	Type	Exhaust	A,B(CYL) Port
DS3○30-○○ <sup>01</sup> / <sub>02</sub>	B Mount	30	Common Valve

Manifold Specifications		
Manifold Type	B Mount(Single Base Type)	
Exhaust	Common	Individual(Pilot)
Maximum Stations	20 Stations ※	

※ If there are more than 8 stations use both supply and all 4 exhaust ports.

Manifold Type	Model	Exhaust Port	Piping Port location			Port Size NPT			Applicable Valve
			P(SUP)	R(EXH)	A,B(CYL)	P(SUP)	R(EXH)	A,B(CYL)	
B Mount	DSM3-30	Common	Side/	Side/	Side/	1/4	1/4	1/8	DS3○30
			Base	Base	Valve			1/4	

### 5 Port Solenoid Valve Series DS5000

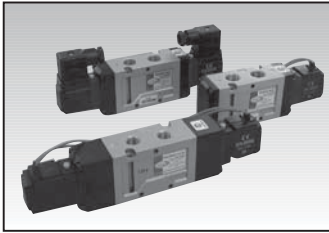

- Compact size and light weight
- Large flow capacity
- Low power consumption
- Designed for non-lubricated service

Body Ported Type	Model	Port Size		Position	Solenoid	Effective Orifice mm <sup>2</sup> (Cv)		Pressure kgf/cm <sup>2</sup> (psi)
		DS	UDS			3/8	1/2	
5 Port	DS5120	RC(PT)	NPT	2	Single	50(2.8)	58(3.2)	1.5~9(21~128)
	Double				50(2.8)	58(3.2)	1~9(14~128)	
	DS5320	1/2	1/2	3	Closed Center	40(2.2)	45(2.5)	1.5~9(21~128)
	DS5420				Exhaust Center	43(2.4)	48(2.7)	1.5~9(21~128)

### How to Order

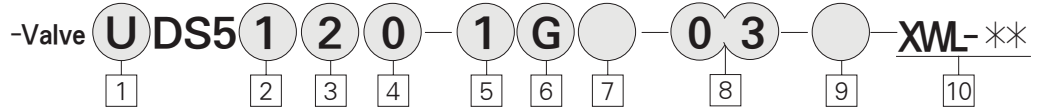

**1** DS5000 Series

Blank : Metric Rc(PT)  
 U : NPT

**2** Type of Actuation

- 1 : 2 Position/Single Solenoid
- 2 : 2 Position/Double Solenoid
- 3 : 3 Position/Closed Center
- 4 : 3 Position/Exhaust Center
- 5 : 3 Position/Pressure Center

**3** Body Type

2 : For 20 Type Manifold Body Ported

**4** Body Option

- 0 : Standard
- 3 : Common Exhaust for Main and Pilot Valve

**5** Voltage

1 : AC110V, 50/60Hz

- 2 : AC220V, 50/60Hz
- 3 : AC120V, 50/60Hz
- 4 : AC240V, 50/60Hz
- 5 : DC24V
- 6 : DC12V
- 7 : DC6V
- 8 : AC24V, 50/60Hz, Others
- 9 : DC100V

**6** Electronic Entry/Indicator Light and Surge Suppressor

- G : Grommet (Lead Wire Length 300mm)
- DZ : DIN Connector with Indicator Light and Surge Suppressor
- N : W/D DIN Connector

**7** Manual Override

Blank : Non-Locking PushType

C : Knob Locking Type

**8** Port Size (Sup., Cyl.)

- 02 : RC(PT) 1/4
- 03 : 3/8
- 04 : 1/2 (Exhaust Port: 3/8)

**9** Special Option

Blank : Standard Type  
 XC16 : Copper-Free

**10** Length of lead wire

- Blank : 300mm (Standard)
- XWL01 : 100mm
- XWL02 : 200mm
- ...
- XWL20 : 2000mm
- ∴ Other length : Contact us

< Symbol >

Single DS5120

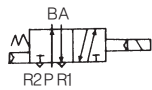

Double DS5220

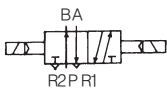

Closed Center DS5320

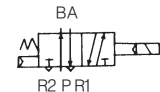

Exhaust Center DS5420

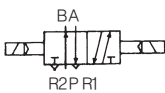

Pressure Center DS5520

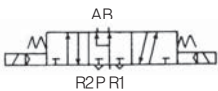

- Manifold Base **U** **DSM5** - **20** - **05** **1**

1
2

**1** Series for DS5000 series

Blank : Metric Rc(PT)  
 U : NPT  
 P(SUP) 1/2  
 R1, R2(EXH) 3/8

**2** Stations

- 02 : 2 stations
- ...
- 10 : 10 stations

- Pilot Valve Assembly Only **SC2** - **1** **G** - **50** - **XWL** - \*\*

1
2
3
4
5

**1** Voltage

- 1 : AC110V, 50/60Hz
- 2 : AC220V, 50/60Hz
- 3 : AC120V, 50/60Hz
- 4 : AC240V, 50/50Hz
- 5 : DC24V
- 6 : DC12V
- 7 : DC6V
- 8 : AC24V, 50/50Hz, others
- 9 : DC100V

**2** Electrical Entry/Indicator Light and Surge Suppressor

- G : Grommet (Lead wire length 300mm)
- DZ : DIN Connector With Indicator Light and Surge Suppressor

**3** Manual Override

Blank : Non-locking Push Type  
 C : Knob locking Type

**4** Special Option

Blank : Standard Type  
 XC16 : Copper-Free

**5** Length of lead wire

- Blank : 300mm (Standard)
- XWL01 : 100mm
- XWL02 : 200mm
- ...
- XWL20 : 2000mm
- ∴ Other length : Contact us

DS3000  
**DS5000**  
 DP300/  
 3000/5000  
 DS6000  
 DS3000  
 (Base Ported)  
 DX1,2  
 DX2R  
 DH  
 DW  
 DM  
 DT220/  
 UD1220/DC  
 TPC-1000  
 /1200  
 PC  
 PF  
 PR  
 PL  
 PP  
 PFH/  
 PFU  
 PLV  
 TXF  
 PVR/PNR  
 PER2000  
 /3000  
 TAD  
 EP  
 EM/EL  
 SP5A  
 SPS  
 SQ  
 SC  
 SP  
 SP4000  
 /SPM  
 SP2000  
 SN  
 SQ2  
 SH  
 DCH  
 SF  
 ST  
 W1  
 W2/W3  
 W4/W5  
 W6/W7  
 Mini  
 Auto Switch

## Specifications

Fluid		Air
Operating Pressure Range	2 Position Single · 3Position	1.5~9 kgf/cm <sup>2</sup> (21~128 psi)
	2 Position Double	1~9 kgf/cm <sup>2</sup> (14~128 psi)
Ambient and Fluid Temperature		Max. 50°C(122°F)
Response Time	2 Position Single/Double	40 ms or Less {5kgf/cm <sup>2</sup> (71 psi)}
	3Position	50 ms or Less {5kgf/cm <sup>2</sup> (71 psi)}
Max. Operating Frequency	2 Position Single/Double	5 c/s
	3 Position	3 c/s
Lubrication		Not Required※
Manual Override		Non-Locking Push Type, Knob Locking Type
Mounting Position		Free
Impact/Vibration Resistance		30G/5G(8.3~200Hz)
Enclosure		Dust Proof

※ If provided, use Turbine 1Class(ISO VG #32)

Electical Entry		Grommet, DIN Connector	
Coil Voltages	AC 50/60Hz	100V, 200V, 120V, 240V, 24V	
	DC	6V, 12V, 24V	
Allowable Voltage		-15 ~ +10% of Rated Voltage	
Power Consumption	AC	Starting	5.6VA(50Hz), 5.0VA(60Hz)
		Holding	3.4VA(50Hz), 2.3VA(60Hz)
		DC	1.8W/2W(With LED)
Indicator Light/Surge		AC	LED, Varistor
Suppressor Circuit		DC	LED, Varistor

## Model for Manifold

Model	Type	Exhaust	A,B(CYL) Port
DS5○20-○○ <sup>03</sup> <sub>04</sub>	B Mount	20	Common Valve

## Manifold Specifications

Manifold Type	B Mount
Exhaust	Common Exhaust
Maximum Stations	10 Stations

Manifold Type	Model	Exhaust Port	Piping/Port Location			Port Size			Applicable Valve
			P	R	A,B	P	R	A,B	
B Mount	DSM5-20 UDSM5-20	Common	Side/	Side/	Top	3/8	3/8	3/8	DS5○20 UDS5○20
			Base	Base	Valve	1/2		1/2	

### 3 · 5 Port Air Pilot Valve Series DP300/3000/5000

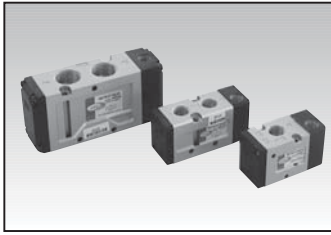

- Compact size and light weight
  - 26.4mm / 0.63inch width (series DP300, DP3000 / UDP300, UDP3000)
  - 32mm / 1.26inch width (series DP5000 / UDP5000)
- Large flow capacity
  - Cv. 1.0 - Rc(PT)1/4 (DP300, DP3000)
  - NPT 1/4(UDP300, UDP3000)
  - Cv. 3.2 - Rc(PT) 1/2(DP5000)
  - NPT 1/2(UDP5000)

Body Ported Type	Model	Port Size		Position	Solenoid	Effective Orificem <sup>2</sup> (Cv) RC(P,T)		Ported Pressure kgf/cm <sup>2</sup> (psi)
		DS	UDS					
3way	DP301	RC(PT) 1/8, 1/4	NPT 1/8, 1/4	2	Single	1/8:14(0.8)	1/4:18(1.0)	1.5~9(21~128psi)
5way	DP3130	RC(PT) 1/8, 1/4	NPT 1/8, 1/4	2	Single	1/8:14(0.8)	1/4:18(1.0)	1.6~9(21~128psi)
	DP3230				Double	1/8:14(0.8)	1/4:18(1.0)	1.0~9(21~128psi)
	DP5120	RC(PT) 3/8, 1/2	NPT 3/8, 1/2	2	Single	3/8:48(2.8)	1/2:58(3.2)	1.6~9(21~128psi)
	DP5220				Double	3/8:48(2.8)	1/2:56(3.2)	1.2~9(17~128psi)

#### How to Order

#### DP3000

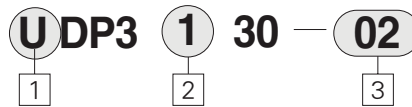

- 1 Series  
Blank : Metric Rc(PT)  
U : NPT
- 2 Type of Actuation  
1 : Single Pilot type  
2 : Double Pilot type
- 3 Port Size(P, A, B)  
01 : 1/8  
02 : 1/4  
\* Exhaust Port is only 1/8"

#### DP5000

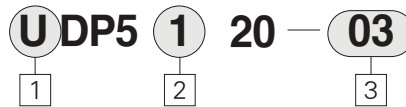

- 1 Series  
Blank : Metric Rc(PT)  
U : NPT
- 2 Type of actuation  
1 : Single Pilot Type  
2 : Double Pilot Type
- 3 Port Size(P, A, B)  
03 : 3/8  
04 : 1/2  
(Exhaust Port is only 3/8")

#### DP301



- 1 Series  
Blank : Metric Rc(PT)  
U : NPT
- 2 Port Size(P, A, B)  
01 : 1/8  
02 : 1/4
- 3 Type of Actuation  
A : Normally Closed  
B : Normally Open

< Symbol >

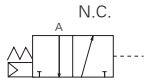

DP 301 Normally Closed

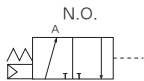

DP 301 Normally Open

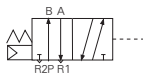

(U)DP 3130  
(U)DP 5120

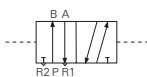

DP 3230  
DP 5220

#### Specifications

Fluid		Air	
Operating Pressure Range	2 Position	Single	1.5~9kgf/cm <sup>3</sup> (21~128psi)
		Double	1~9 kgf/cm <sup>3</sup> (14~128psi)
Ambient and Fluid Temperature		MAX. 60°C(140°F)	
Pilot Pressure Range	2 Position	Single	(Note1) 1.7~9kgf/cm <sup>3</sup> (22~128psi)
		Double	1~9kgf/cm <sup>3</sup> (14 ~ 128psi)
Lubrication		Not required	
Impact/Vibration Resistance		30 / 5 (8.3 ~ 2000Hz)	
Mounting Position		Free	

(Note 1) The minimum pressure for Pilot should be higher than "A"  
P : Supply pressure.      A : (0.5×P+1){0.5×P+0.1}

## 5 Port Solenoid Valve Series DS6000

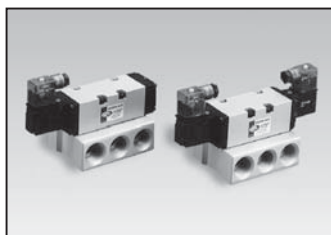

- Compact size and light weight
- Large flow capacity/effective orifice Cv 5.0,
- Low power consumption-1.8w (DC)
- Many variations available
- Compact size and large flow capacity
- Effective orifice 90mm<sup>2</sup>
- Low power consumption

Body Ported Type	Model	Port Size		Position	Solenoid	Effective Orifice mm <sup>2</sup> (Cv)	Pressure kgf/cm <sup>2</sup> (psi)
		DS	UDS				
5 Port	DS6140	Rc(PT) 3/4	NPT 3/4	2	Single	90(5.0)	1.5~9.9(21~128 psi)
	Double				1~9.9(14~128 psi)		
	3			Closed Center	70(3.89)	1.5~9.9(21~128 psi)	
				Exhaust Center			
				Pressure Center			

■ Standard Coil Volatage - 110, 220, 120, 240VAC (50/60Hz), 24VDC

### How to Order

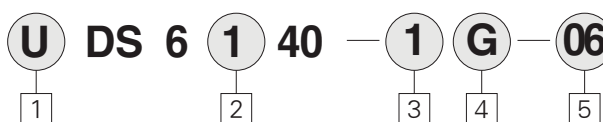

#### < Symbol >

Single

DS6140

(PT 3/4)

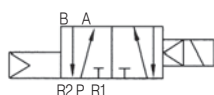

Double

DS6240

(PT 3/4)

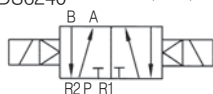

Closed Center

DS6340

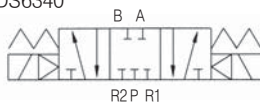

Exhaust Center

DS6440

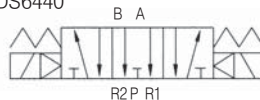

Pressure Center

DS6540

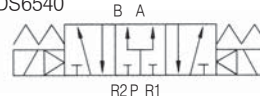

#### 1 Series

Blank : Metric Rc(PT)  
U : NPT

#### 2 Type of Actuation

- 1 : 2 Position Single
- 2 : 2 Position Double
- 3 : 3 Position Closed Center
- 4 : 3 Position Exhaust Center
- 5 : 3 Position Pressure Center

#### 3 Voltage

- 1 : AC 110V, 50/60Hz
- 2 : AC 220V, 50/60Hz
- 5 : DC 24V
- 6 : DC 12V

#### 4 Electrical Entry/ Indicator Light and Surge Suppression

G : Grommet

D : DIN Terminal(standard)  
DN : DIN Terminal(with lamp)  
DZ : DIN Connector(With indicator Light and surge suppressor)

#### 5 Port Size

06 : 3/4

### Specifications

Model	(U)DS6140	(U)DS6240	(U)DS6340	(U)DS6440	(U)DS6540
Fluid	Air				
Operating Pressure Range(kgf/cm <sup>2</sup> )	1.5~9.9	1~9.9	1.5~9.9(21~140psi)		
Effective Orifice mm <sup>2</sup> (Cv)	90(5.0)		70(3.89)		
Ambient and Fluid Temperature	Max. 50℃ (122 °F)				
Response Time(5kgf/cm <sup>2</sup> )	40ms or less		60ms or less		
Max. Operating frequency	5Hz		3Hz		
Lubrication	Not required				
Manual Override	Non-locking Push Type				
Impact/Vibration Resistance	30G/5G(8.3~2000HZ)				
Enclosure	Dust Proof				
Coil Voltage	AC 50/60HZ 110V, 120V, 220V, 240V, DC12V, 24V				
Allowable Voltage	-15%~+10% of Rated Voltage				
Coil Insulation	Class B or equivalent(130℃)(266° F)				
Power Consumption	AC	Inrush	5.6VA(50HZ), 5.0VA(60HZ)		
		Holding	4.5VA(50HZ), 3.8VA(60HZ)		
	DC	1.8W/2W(With LED)			
Weight(kgf)	1.17	1.20	1.22	1.22	1.22
Surge Suppressor Circuit	AC, DC : Varistor				
Indicator Light	LED				

- DS3000
- DS5000
- DP300/  
3000/5000
- DS6000
- DS3000  
(Base Ported)
- DX1,2
- DX2R
- DH
- DW
- DM
- DT220/  
UDT220/DC
- TPC-1000  
/1200
- PC
- PF
- PR
- PL
- PP
- PFFH/  
PFU
- PLV
- TXF
- PVR/PNR
- PER2000  
/3000
- TAD
- EP
- EM/EL
- SPSA
- SPS
- SQ
- SC
- SP
- SP4000  
/SPM
- SP2000
- SN
- SQ2
- SH
- DCH
- SF
- ST
- W1
- W2/W3
- W4/W5
- W6/W7  
Mini  
Auto Switch

### 5 Port Pilot Solenoid Valve Sub Base Type Series DS3000

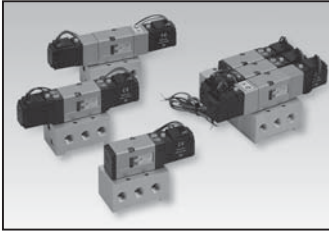

- Low power consumption/1.8WDC
- Large flow capacity/Cv0.9
- Compact light weight design
- Designed for non-lubricated Service

< Symbol >

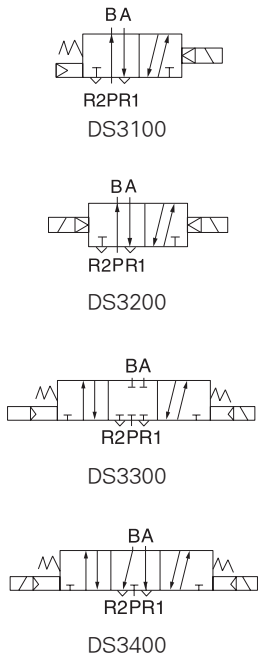

Model	Port Size		Position	Solenoid	Effective Orifice mm <sup>2</sup> (Cv)	Pressure kgf/cm <sup>2</sup> (psi)
	DS	UDS				
DS3100	RC(PT) 1/4	NPT 1/4	2	Single	16(0.9)	1.5~9(21~128)
DS3200				Double		1~9(14~128)
DS3300			3	Closed Center	12.5(0.7)	1.5~9(21~128)
DS3400				Exhaust Center		

### How to Order

- Valve + Sub Base

DS 3 **1** 0 0 **5** **G** **L** **8A** **06** **XC16** **XWL**-\*\*

1
2
3
4
5
6
7
8
9

**1** Type of Actuation

- 1 : 2 Position/Single Solenoid
- 2 : 2 Position/Double Solenoid
- 3 : 3 Position/Closed Center
- 4 : 3 Position/Exhaust Center

**2** Body Option

- 0 : Standard
- 3 : Common Exhaust for Main and Pilot Valve

**3** Voltage

- 1 : AC110V, 50/60Hz
- 2 : AC220V, 50/60Hz
- 3 : AC120V, 50/60Hz
- 4 : AC240V, 50/60Hz
- 5 : DC24V
- 6 : DC12V
- 7 : DC6V
- 8 : AC24V(50/60Hz)
- 9 : Other

**4** Electronic Entry/Indicator Light and Surge Suppressor

- G : Grommet (Lead Wire Length 300mm)
- DZ : DIN Connector with Indicator Light and Surge Suppressor
- N : DIN Connector (Without Din type Connector)

**5** Manual Override

- Blank : Non-Locking PushType
- L : Knob Locking Type

**6** Port Size (Sup., CYL)

- Blank : Valve Body Only (without Sub Plate)
- 8A : Rc(PT)1/4 (with Sub Plate)
- U8A : NPT1/4 (with Sub Plate)

**7** One-Touch Fitting

- Blank : Without One-Touch Fitting
- 06 : φ6 One-Touch Fitting
- 08 : φ8 One-Touch Fitting

**8** Special Option

- Blank : Standard Type
- XC16 : Copper-Free

**9** Lead wire length

- Blank : 300mm(standard)
- XWL01 : 100mm
- XWL02 : 200mm
- ∴ Other length : Contact us

- Manifold

**U** **DSM** **3** — **00** — **02** — **0**

1
2
3

**1** Thread

- Blank : Metric RC(PT)1/4
- U : NPT

**2** Stations

- 01 : 1 station
- 02 : 2 stations
- 03 : 3 stations
- ∴
- 10 : 10 stations

**3** One-Touch Fitting

- Blank : Without
- 06 : φ6 One-Touch Fitting
- 08 : φ8 One-Touch Fitting

- Blanking Plate

**DSB** **3** — **00** (Including Gasket & Bolt)

Specifications		
Fluid		Air
Operating Pressure Range	2 Position Single · 3Position	1.5~9 kgf/cm <sup>2</sup> (21~128 psi)
	2 Position Double	1~9 kgf/cm <sup>2</sup> (14~128 psi)
Ambient and Fluid Temperature		50°C(122°F)
Response Time	2 Position Single/Double	30 ms or Less (0.5 Mpa)
	3Position	40 ms or Less (0.5 Mpa)
Max. Operating Frequency	2 Position Single/Double	5 Hz
	3 Position	3 Hz
Lubrication		Not Required*
Manual Override		Non-Lock Push Type, Knob Lock Type
Mounting Position		Free
Impact/Vibration Resistance		30G/5G(8.3~200Hz)
Enclosure		Dust Proof
Pilot Exhaust		Individual Exhaust, Common Exhaust for Main Valve and Pilot Valve

Electrical entry		Grommet, DIN Connector	
Coil Voltages	AC 50/60Hz	110 or 100V, 200 or 220V, 120V, 240V, 24V	
	DC	6V, 12V, 24V	
Allowable Voltage		-15~ + 10% of rated voltage	
Power Consumption	AC	Starting	5.6VA(50Hz), 5.0VA(60Hz)
		Holding	3.4VA(50Hz), 2.3VA(60Hz)
		DC	1.8W/2W(With LED)
Indicator Light/Surge	AC	LED, Varistor	
Suppressor Circuit	DC	LED, Varistor	

**5 port Solenoid valve /  
Elastic SEAL (ISO#1, #2)  
Series DX1, 2**

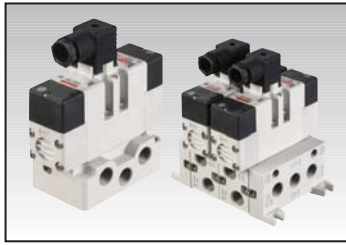

- Easy to replace Sol V/V
- Prevent leaving bolt (integration)
- Protect spool from dust by P-MESH
- Easy maintenance (Integrated body / manifold gasket)
- Easy to make manifold assembly with integrated clamp tap
- Compact / Light design
- Attach manifold valve

**How to Order**

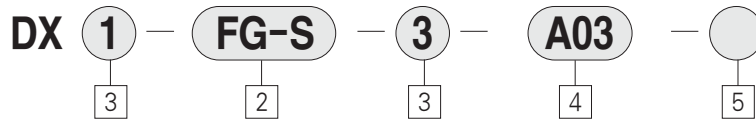

**1** DX1 (ISO Size1)  
DX2 (ISO Size2)

**2** Type of Actuation  
 FG-S : 2Position Single  
 FG-D : 2Position Double  
 FHG-D : 3Position Closed Center  
 FJG-D : 3Position Exhaust Center  
 FIG-D : 3Position Pressure Center

**3** Coil voltage  
 1 : AC100V, 50/60Hz  
 2 : AC200V, 50/60Hz  
 3 : DC24V  
 ※ Surge voltage suppressor is on the basis

**4** SUB PLATE  
 • DX1  
 Blank : none  
 A02 : side-Piping 1/4  
 A03 : side-Piping 3/8  
 B02 : Bottom-Piping 1/4  
 B03 : Bottom-Piping 3/8  
 • DX2  
 Blank : none  
 A03 : side-Piping 3/8  
 A04 : side-Piping 1/2  
 B03 : side-Piping 3/8  
 B04 : Bottom-Piping 1/2

**5** Thread  
 Blank : Rc(PT)  
 U : NPT

<Symbol>

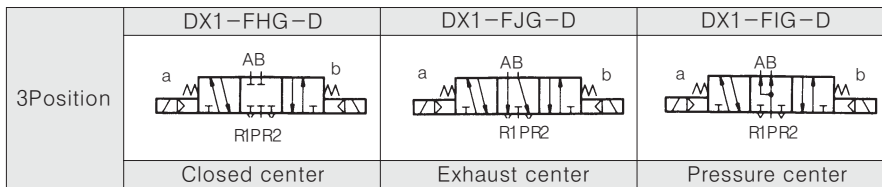
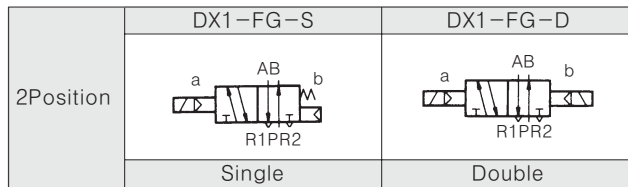

- DS3000
- DS5000
- DP300/3000/5000
- DS6000
- DS3000 (Base Ported)
- DX1,2**
- DX2R
- DH
- DW
- DM
- DT220/UDT220/DC
- TPC-1000/1200
- PC
- PF
- PR
- PL
- PP
- PFH/PFU
- PLV
- TXF
- PVR/PNR
- PER2000/3000
- TAD
- EP
- EM/EL
- SPSA
- SPS
- SQ
- SC
- SP
- SP4000/SPM
- SP2000
- SN
- SQ2
- SH
- DCH
- SF
- ST
- W1
- W2/W3
- W4/W5
- W6/W7  
Mini  
Auto Switch



## Specification

Fluid	Air	
Operating pressure (MPa)	2position Single	0.15~1.0(1.5~10)
	2position Double	0.1~1.0(1~10)
	3position	0.2~1.0(2~10)
Ambient and Fluid Temperature°C	-5~60(antifreezs)	
Manual Operating	Non Lock Push Type	
Lubrication	Non-lube	
Mounting Position	Free	
m/s <sup>2</sup> Impact/ Vibration resistance	150/30(8.3~2000Hz)	
Max. Operating Frequency	2position	5
	3position	3
Protection Structure	IP66	
Roated Voltlage (V)	DC 24, AC 110V, AC220V(50/60Hz)	
Allowable Voltlage (%)	-10~+10 of rated voltage	
Polar	Non-Polar	
Response Time (ms), 0.5MPa {5kg/cm <sup>2</sup> }	Refer to below table	
Power consumption	DC(W)	1.8
Power consumption	AC(VA)	3.5
Effective Orifices mm <sup>2</sup> (CV)	Refer to below table	

## Weight

Item	DX1	DX2	
VALVE	SINGLE	618	
	DOUBLE	678	
	3-POSITION	716	
Manifold	BASE	734	
	SIDE COVER	Left:150	Left:346
		Right:142	Right:356
	SUB PLATE	655	

## Performance (DX1)

Model	Type of Actuation	Port Size	Effective orifice mm <sup>2</sup> (CV)	Response time(ms)
2Position	DX1-FG-S	Rc(PT)3/8	27 (1.5)	ON(Unde 30), OFF(Under 40) Under 30
	DX1-FG-D	Rc(PT)3/8		
3Position	DX1-FHG-D	Rc(PT)3/8	25.2 (1.4)	Under 50
	DX1-FJG-D	Rc(PT)3/8		
	DX1-FIG-D	Rc(PT)3/8		

## Performance (DX2)

Model	Type of Actuation	Port Size	Effective orifice mm <sup>2</sup> (CV)	Response time(ms)
2Position	DX2-FG-S	Rc(PT)1/2	54 (3.0)	Under 45
	DX2-FG-D			Under 30
3Position	DX2-FHG-D	Rc(PT)1/2	50(2.8)	Under 50
	DX2-FJG-D			
	DX2-FIG-D			

## DIN Connector (Wiring)

- Indictor light and Surge Voltage Suppressor

### Single

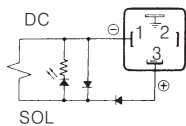
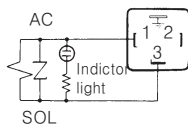

### Double & 3Position

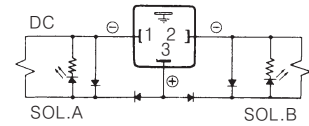
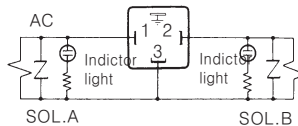

# ISO#2 Interface Regulator Series DX2R

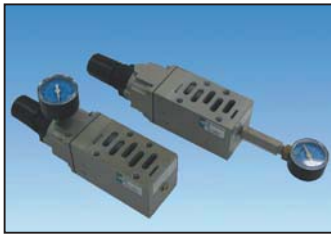

- Sandwich regulator for DX2 valve (ISO#2)
- Light weight (760 g)&design (height 53mm)
- Single handle position

## Series DX2R /Specifications

Proof Pressure	1.5 MPa (217.6 psi)			
Max. Operating Pressure	1.0 MPa (145.1 psi)			
Set Pressure Range	0.1~0.83 MPa (14.2~120.0 psi)			
Pressure Gauge Port Size	Rc(PT) 1/8			
Ambient and Fluid Temperature	5~60°C (41~140 °K)			
Pressure Governor	Relieving Type			
		P Pressure Reducing	A Pressure Reducing	B Pressure Reducing
Air Supply Side Eff. Area(mm <sup>2</sup> ) (Cv)	P → A	27 mm <sup>2</sup> (1.5)	30 mm <sup>2</sup> (1.7)	27 mm <sup>2</sup> (1.5)
	P → A	27 mm <sup>2</sup> (1.5)	30 mm <sup>2</sup> (1.5)	27 mm <sup>2</sup> (1.5)
Air Exhaust Side Eff. Area(mm <sup>2</sup> ) (Cv)	A → R1	60 mm <sup>2</sup> (3.3)		
	B → R2	36 mm <sup>2</sup> (2.0)		

## How to Order

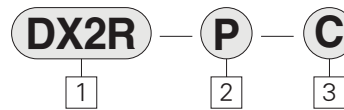

1 Sandwich Regulator (ISO #2)

2 Regulation Port

- P : P port regulation
- A : A port regulation
- B : B port regulation

3 Gauge Type

Blank : Radial Type Gauge

C : Cylindrical Type Gauge(Single Only)

Gauge	Type	Port	order No.
Blank	Horizontal	RC 1/8	DX2R-16-3000
C	Vertical	RC 1/8	TAR4000-16-6001
		NP 1/8	UPR4000-16-6001

## Symbol

Model	Regulation Port	Pressure Gauge Port Size	Pressure Governor	Symbol
DX2R-P	P port regulation	Rc (PT) 1/8	Relieving Type	 P1 P1 A P B R2 P2
DX2R-A	A port regulation			 P1 P1 A P B R2 P2
DX2R-B	B port regulation			 P1 P1 A P B R2 P2

- DS3000
- DS5000
- DP3000/3000/5000
- DS6000
- DS3000 (Base Ported)
- DX1,2
- DX2R
- DH
- DW
- DM
- DT220/UDT220/DC
- TPC-1000/1200
- PC
- PF
- PR
- PL
- PP
- PFH/PFU
- PLV
- TXF
- PVR/PNR
- PER2000/3000
- TAD
- EP
- EM/EL
- SPSA
- SPS
- SQ
- SC
- SP
- SP4000/SPM
- SP2000
- SN
- SQ2
- SH
- DCH
- SF
- ST
- W1
- W2/W3
- W4/W5
- W6/W7 Mini Auto Switch

# Hand Valve Series DH



- Porting of Rc(PT) 1/4, 3/8 and 1/2
- Improved abrasion resistance
- Aluminum die casting design for heavy applications
- Detented center position

Model						
Series	Port Size		Number of Positions	Effective Orifice mm <sup>2</sup> (Cv factor)	Weight (kgf)	Piping
	DH	UDH				
DH200	Rc(PT)1/4	NPT1/4	3(Closed Center)	7.5(0.4)	0.55	
DH300	Rc(PT)3/8	NPT3/8	3(Closed Center)	20(1.1)	0.9	
DH400	Rc(PT)1/2	NPT1/2	3(Closed Center)	55(3.1)	1.6	
DH202	Rc(PT)1/4	NPT1/4	2Position	7.5(0.4)	0.55	
DH302	Rc(PT)3/8	NPT3/8	2Position	20(1.1)	0.9	
DH402	Rc(PT)1/2	NPT1/2	2Position	55(3.1)	1.6	

## How to Order

< Symbol >

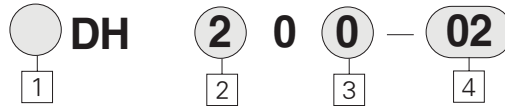
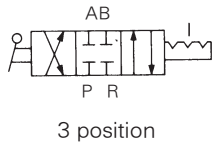
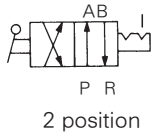

**1 Series**

Blank : Metric(PT)  
U : NPT

**2 Body Size**

2 : Cv 0.4(1/4" NPT(PT) Only)  
3 : Cv 1.1(3/8" NPT(PT) Only)  
4 : Cv 3.1(1/2" NPT(PT) Only)

**3 Position Symbol**

0 : 3 Position Closed Center  
2 : 2 Position

**4 Port Size**

02 : 1/4  
03 : 3/8  
04 : 1/2

## Standard Specifications

Fluid	Air
Proof Pressure	1.5kgf/cm <sup>2</sup> (200 psi)
Max. Operating Pressure	9.9kgf/cm <sup>2</sup> (140 psi)
Ambient and Operating Fluid Temperature	5~60°C(40~140°F)
Operating Angle	90°

## Flow Characteristics

DH200

Effective area S=7.5mm<sup>2</sup>

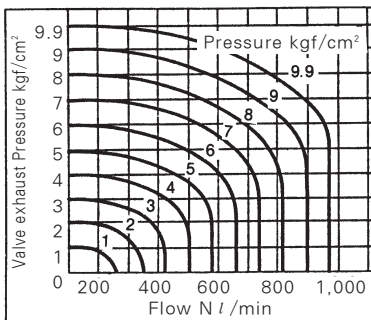

DH300

Effective area S=20mm<sup>2</sup>

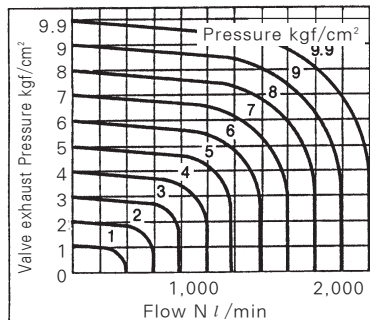

DH400

Effective area S=55mm<sup>2</sup>

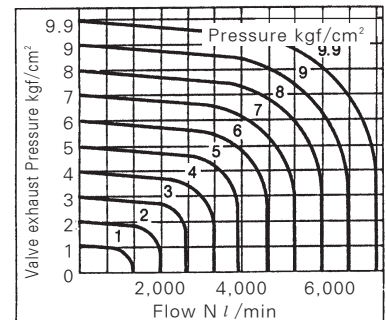

## 2 Port Valve Series DW



- Wide range of operating pressures  
0~7kgf/cm<sup>2</sup>(0~99.5psi)  
0~10kgf/cm<sup>2</sup>(0~142.2psi)  
0.3~10kgf/cm<sup>2</sup>(4.26~142.2psi)
- High flow capacity
- Efficient solenoid energy

< Symbol >

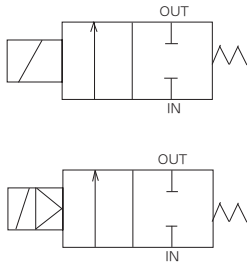

Model						
Type	Port (Size)	Orifice Size (φ mm)	Effective orifice mm <sup>2</sup> (Cv)	Pressure	Solenoid Type	Weight(kgf)
DW03-*G-0 1	1/8(6A)	2.5	6 (0.3)	0~7kgf/cm <sup>2</sup> {0~99.5 psi}	Direct	0.3
DW03-*G-0 2	1/4(8A)	2.5	6 (0.3)		Direct	0.3
DW10-*C-0 2	1/4(8A)	10	34(1.9)	AC:0~10kgf/cm <sup>2</sup> (0~142.2psi) DC:0.3~7kgf/cm <sup>2</sup> (4~99.5psi)	Pilot	0.5
DW10-*C-0 3	3/8(10A)	10	43 (2.4)		Pilot	0.5
DW15-*C-0 4	1/2(15A)	15	160 (8.9)		Pilot	0.7
DW20-*C-0 6	3/4(20A)	20	170 (9.4)	0.3~10kgf/cm <sup>2</sup> {4~142psi}	Pilot	0.9
DW25-*C-10	1(25A)	25	225 (12.5)		Pilot	1.2

### How to Order

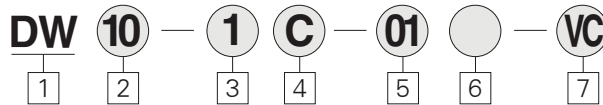

**1** 2 Port Solenoid Valve

DW : (Water,Air,Oil)  
※ DWS : Steam

**2** Body(Orifice) Size mm(inch)

-Direct Type Solenoid  
03 : φ 2.5(0.1)  
-Pilot Type Solenoid  
10 : φ 10(0.4)  
15 : φ 15(0.6)  
20 : φ 20(0.8)

25 : φ 25(1.0)

**3** Voltage

1 : AC110V, 50/60Hz  
2 : AC220V, 50/60Hz  
5 : DC24V  
9 : Other

**4** Electric Connection

G, C : Grommet (only DW03 / UDW03)

**5** Port Size(PT)

01 : 1/8"      02 : 1/4"  
03 : 3/8"      04 : 1/2"  
06 : 3/4"      10 : 1"

**6** Blank : Standard

S : Sus Type(over 15 φ)

**7** VC : For Vacuum Type(-100kpa)

※ Constant Voltage : Both AC, DC available

### Standard Specifications

Applicable	Air, Water, Oil		
Proof Pressure	15kgf/cm <sup>2</sup> (213psi)		
Fluid Temperature	0~70° C (32~158°F)		
Temperature Rise	Max. 60° C(Max.140°F)		
Electrical Entry	Conduit		
Actuation Type	Direct or Pilot Solenoid		
Valve Type	Normally Closed		
Seat Type	Poppet		
Rated Voltage	AC (50/60Hz)	110V, 220V	
	DC	24V	
Voltage Range	Rated Voltage ±10%		
Coil Insulation	Class B or Equivalent(110℃)		
Power Consumption	AC	Starting	17VA (60Hz)
		Holding	15VA (60Hz)
	DC	11W	
Materials(Standard)	Body	BC6	
	Seal Materials	NBR	

- DS3000
- DS5000
- DP3000/3000/5000
- DS6000
- DS3000 (Base Ported)
- DX1,2
- DX2R
- DH
- DW
- DM
- DT220/UD1220/DC
- TPC-1000/1200
- PC
- PF
- PR
- PL
- PP
- PFH/PFU
- PLV
- TXF
- PVR/PNR
- PER2000/3000
- TAD
- EP
- EM/EL
- SPSA
- SPS
- SQ
- SC
- SP
- SP4000/SPM
- SP2000
- SN
- SQ2
- SH
- DCH
- SF
- ST
- W1
- W2/W3
- W4/W5
- W6/W7 Mini Auto Switch

### 3 · 5 port Mechanical Valve Series DM

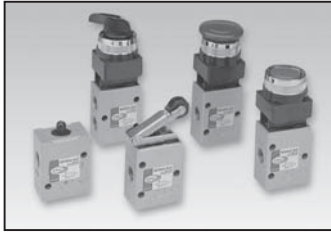

● Interchangeable actuators

Model	Port Size	Types of Actuators	Pressure kgf/cm <sup>2</sup> (psi)	Effective Orifice mm <sup>2</sup> (Cv)
DM230	Rc(PT) 1/8	2Position, 3Port	0~7(0~100)	11.0(0.6)
DM330	Rc(PT) 1/4	2Position, 3Port		19.0(1.0)
DM450	Rc(PT) 1/8	2Position, 5Port	1.5~7(21~100)	14.0(0.7)
DM550	Rc(PT) 1/4	2Position, 5Port		19.0(1.0)

### How to Order

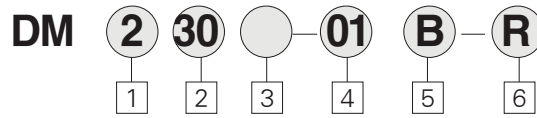

**1 Body Type**

- 2 : B Type
- 3 : C Type
- 4 : D Type
- 5 : E Type
- \*refer to the Below dimensions

**2 Type of Actuation**

- 30 : 2 Position 3 Port N.O./N.C.
- 50 : 2 Position 5 Port

**3 Bracket**

- Blank : Non
- B : Bracket

**4 Port Size(NPT)**

- 01 : 1/8"(DM230, 450 Only)
- 02 : 1/4"(DM 330, 550 Only)

**5 Actuator**

- B : Basic Type
- R : Roller Plunger Type
- E : Push Button(Mushroom) Type
- P : Push Button(Flush) Type
- S : Selector Type
- R2 : One Way Trip (Resin)
- RB2 : One Way Trip Actuated (Roller Bearing)

**6 Color(switch)**

- Blank : Red
- G : Green
- B : Black

PART NO. of Mounting Bracket  
(Inquire separately)

- DM 450 : DM - 4B
- DM 550 : DM - 5B
- ∴DM230,330 : non Bracket

[unit:mm]

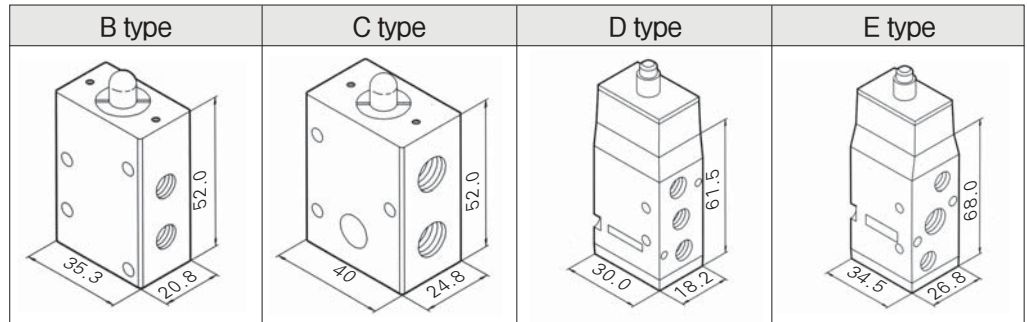

### Specifications

Series	DM230	DM330	DM450	DM550
Fluid	Air , Inert Gas			
Operating Pressure Range	0~7kgf/cm <sup>2</sup> (0~100psi)		1.5~7kgf/cm <sup>2</sup> (21~100psi)	
Effective Orifice mm <sup>2</sup> (Cv)	11.0(0.6)	19.0(1.0)	14.0(0.7)	19.0(1.0)
Lubrication	Not Required			
Port Size Rc(PT)	1/8	1/4	1/8	1/4
Weight Oz.(g)	3.10(88)	4.38(125)	5.75(163)	6.68(191)
Actuator	Basic Type, Roller Plunger, Roller, Push Button(Mushroom), Push Button(Flush), Selector			
Symbol				

## OR Valve (Shuttle Valve) Series DT220/UDT220



- 3 Ported check valve with one output and 2 pneumatic signal input ports.
- Output always supplied by high pressure Inlet

< Symbol >

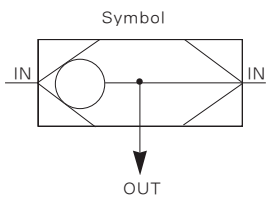

### Model / Specifications

Model	DT 220-02
Port Size Rc(PT), NPT	1/4
Max. Operating Pressure	9.9 kgf/cm <sup>2</sup> (140.8psi)
Min. Pressure Differential	0.5 kgf/cm <sup>2</sup> (7.1psi)
Ambient and Fluid Temperature	0~60°C(21~140°F)
Effective Area mm <sup>2</sup> (Cv)	19(1.0)

### Construction / Dimensions

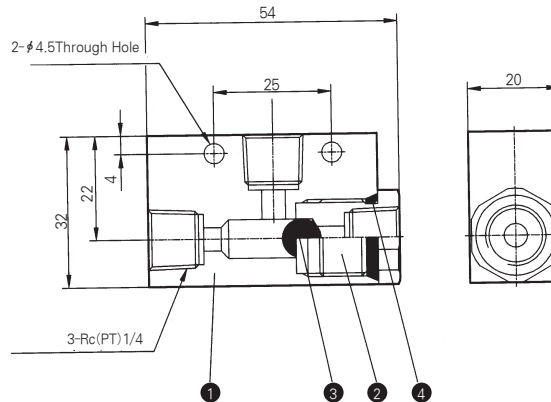

### How to Order

**U** DT220-02

1

1 Series

Blank : Rc(PT)1/4  
U : NPT1/4

2

2 Port Size

02 : 1/4

### Component Parts

No.	Description	Material	Notes
1	Body	Aluminum Alloy	
2	Bush	Carbon Steel	
3	Ball	N.B.R	
4	Gasket	N.B.R	

## Check Valve Series DC

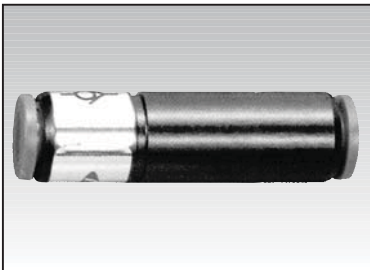

- The Check Valve permits the air flow in one direction but check the flow in the opposite direction, thus keeping the output Pressure at a constant level.

### Structures

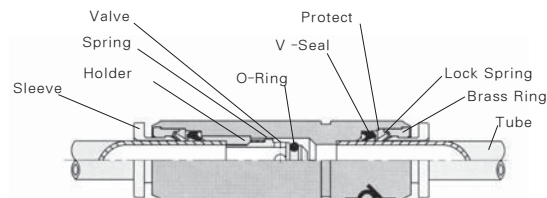

### Dimensions

DC Type

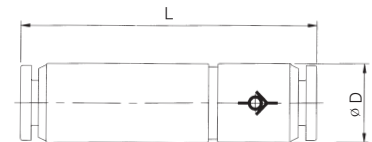

### Specifications

Fluid Admitted	Air, Vacuum
Working Pressure	0.2~9.9kgf/cm <sup>2</sup> (2.84~140.8psi)
Temperature Range	0~60°C(32~140°F)

Unit: mm

Model	Tube size	L	D
DC-04	4	38.7	10.6
DC-06	6	44.5	12.6
DC-08	8	48.5	14.6

DS3000

DS5000

DP300/  
3000/5000

DS6000

DS3000  
(Base Ported)

DX1,2

DX2R

DH

DW

DM

DT220/  
UDT220/DC

TPC-1000  
/1200

PC

PF

PR

PL

PP

PFH/  
PFU

PLV

TXF

PVR/PNR

PER2000  
/3000

TAD

EP

EM/EL

SPSA

SPS

SQ

SC

SP

SP4000  
/SPM

SP2000

SN

SQ2

SH

DCH

SF

ST

W1

W2/W3

W4/W5

W6/W7  
Mini  
Auto Switch