

OPERATING INSTRUCTIONS

Operating Instructions:

Connecting Action:

- Place lever in the in-line position then insert connector onto test piece. Make sure test piece is inserted to the required minimum insertion length (see chart). This will assure proper location relative to the main seal.

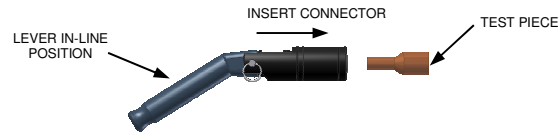

- Rotate lever 90 degrees to the grip and seal position.

Note: Preferred position of lever as shown with test media port on top.



- Introduce test media through test port.

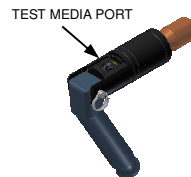

Disconnecting Action:

- Vent test media pressure.
- Rotate lever to the in-line position to release gripping action.
- A slight forward motion of the connector toward the test piece opens the locking collets.

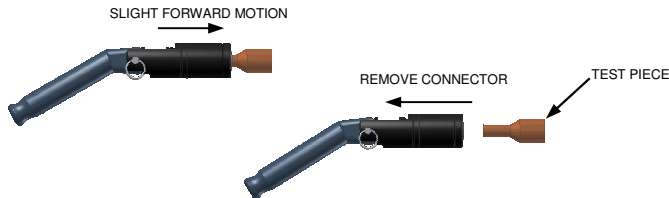

- Remove connector.

Note: The safety design of the pressure assisted gripping collets will not release under pressure.

CAUTION: If excessive operating force or stickiness of the collet/seal assembly is noted, remove collet/seal assembly (See Collet Set Removal and Installation:) and check for alignment and lightly lube the bore of the housing with a petroleum jelly or other compatible lubricant.

Dimensional Information:

JXL EXTERNAL LEVER ACTION *Nudaws*

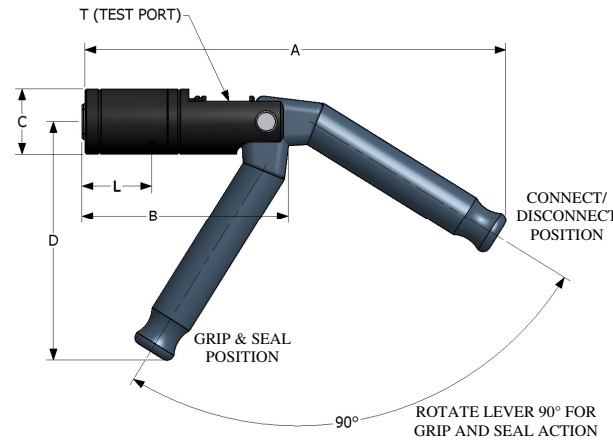

BODY SIZE	A	B	C	D	MAX FLOW Ø	L	T
JXL0	7.25	3.65	1.12	4.13	.24	.79	1/8-27 NPTF
JXL1	7.25	3.58	1.62	4.22	.37	.85	1/4-18 NPTF

(L=Minimum Insertion Depth)

Collet Set Removal and Installation:

Collet Removal:

- Place lever in the in-line position with housing (A) pointed downward, unscrew from body (B). Use finger to keep main seal (F), washer (E) collets (D) and retaining rings (C) inside housing (A).



- Keeping all components inside housing place housing on flat surface then lift housing off of internal components.



- Collet Set components are now exposed for inspection or replacement.

Collet Installation:

- First step, assemble collet segments (D) and retaining rings (C), form two pieces of collets into a half circle and hold between thumb and middle finger. The raised portion of the collets should be toward your thumb with the retaining ring groove facing out.

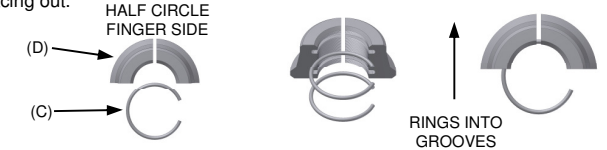

- Place the retaining rings (C) into the grooves in collets.
- Add the last two pieces of collets to form a circle. Hold collet assembly together in one hand.



- Stack as shown. Set the collet assembly, largest side down, on the washer.

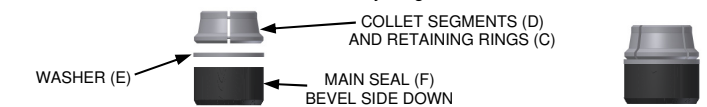

- Place housing (A), threaded side first, over the completed collet assembly stack.



- Slide the housing/collet assembly to the edge of the table and as you slide it off the edge use your index finger to hold the seal/collet assembly in place inside housing.

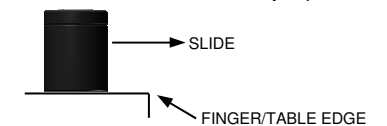

- Push on the seal, washer and collet assembly from the back to move it to the front of the housing.
- Turn housing over so that the threaded end is pointed up and screw connector body onto housing. Tighten hand tight until the body o-ring (G) seals. The piston assembly that contains the test port may also rotate. This can be realigned after the housing is snug.
- If collets are not aligned properly in the seal casing, the casing will not thread on completely. When this occurs, loosen the housing and adjust the collet assembly, you may have to start procedure again from step #1 above.
- With collet in place and housing snugly tightened, rotate the lever to actuate connector. Visually verify that the connectors gripping and sealing action is correct.

Continued on other side:

OPERATING INSTRUCTIONS



- Attach assembled *NuLaws* connector to a test piece and tug on the connector to assure proper engagement and gripping of the collet before introduction of pressurized test media.

Main Seal Removal and Installation:

Removal:

- Place lever in the in-line position so that seal/collet assembly is in the relaxed position. With housing (A) pointed downward, unscrew housing from body (B). Spring assembly remains in body.



- Place housing (A) flat on table with threads up, using a pointed repair tool, pick main seal (F) out of housing (A). Washer (E) and collets (D) remain inside housing (A).

- Verify correct size and material of replacement main seal.
- Lightly lube O.D. of main seal and I.D. of the housing with an o-ring lubricant such as petroleum jelly or other compatible lubricant.

Installation:

- Place replacement main seal (F) bevel side up into housing and slide it down against washer (E).
- Screw body (B) into housing (A). Tighten hand tight until the body o-ring (G) seals. The piston assembly that contains the test port may also rotate. This can be realigned after housing (A) is snug.
- Rotate lever to actuate connector. Visually verify that the connector gripping and sealing action is correct.

CAUTION: Attach assembled *NuLaws* connector to a test piece and tug on the connector to assure proper engagement and gripping of collet before introduction of pressurized test media.

Safety Warnings – General Guidelines:

- If instructions are not completely understood by operator or components are missing, contact **FasTest** before attempting use of the connector.
- All operating parameters should be considered when connector selection is made. Parameters include, but are not limited to: dimensional tolerance, hardness and surface finish of test piece, pressure or vacuum requirements of application, fluid compatibility, temperature, environment and mechanical load or vibration affecting the connector.
- FasTest** JXL Connectors must only be used with test pieces of a specific size as indicated by the part number. Improper use could cause separation of the connector from the test piece resulting in physical harm or damage. The connector part number and maximum pressure rating is marked clearly on the label.

- CAUTION REMINDER:** Keep fingers or other objects away from gripping collets when actuating connector. Pinching or crushing can occur.
- FasTest** JXL Connectors are not internally valved, and will not prevent loss of media when disconnected. Do not attempt to disconnect unless safe conditions are met.

Connector Maintenance:

- A daily, weekly and periodic inspection of the connector by competent person is recommended. User must establish a regular interval for maintenance as determined by the user media and operational environment.
- Lubricate connector on regular intervals. Petroleum jelly is recommended but care should be taken to verify the lubricant is compatible with the application.
- Inspection should include visual checks of the collet sealing area, housing, missing or loose components, leak tightness, ease of operation, sufficient lubrication, wear, dirt accumulation and damage.
- Use only original **FasTest** spare parts that are designed for the application and are subject to strict quality control. See warranty.

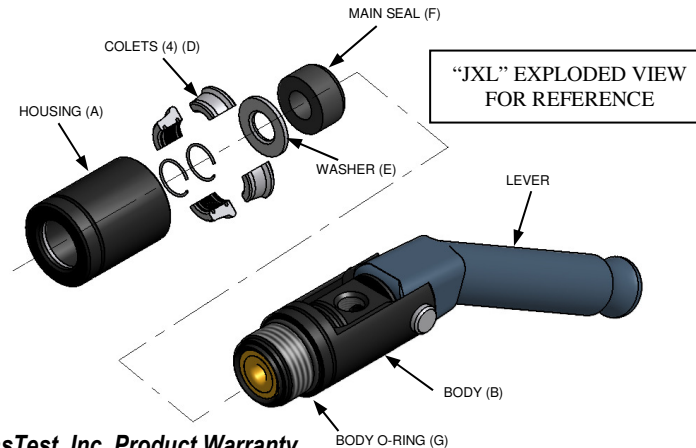

FasTest, Inc. Product Warranty

FasTest, Inc. warrants its products against defects of workmanship and/or material for 12 months from the date of the sale by FasTest, Inc. This warranty is void if the product is misused, tampered with or used in a manner that is not in accordance with FasTest, Inc. recommendations and/or instructions. FasTest, Inc. is not liable for consequential or other damages including, but not limited to, loss, damage, personal injury, or any other expense directly or indirectly arising from the use of or inability to use its products either separately or in combination with other products. ALL OTHER WARRANTIES EXPRESSED OR IMPLIED, WHETHER ORAL OR WRITTEN, INCLUDING BUT NOT LIMITED TO WARRANTIES OF MERCHANTABILITY OR FITNESS FOR A PARTICULAR PURPOSE ARE EXPRESSLY EXCLUDED. Remedy under this warranty is limited to replacement of the product or an account credit in the amount of the original selling price, at the option on FasTest, Inc. All allegedly defective products must be returned prepaid transportation to FasTest, Inc. along with information describing the products performance, unless disposition in the field is authorized in writing by FasTest, Inc.

NuLaws JXL Lever Action Grip and Seal Connectors.

DESCRIPTION: JXL Series Connectors seal on the outside diameter of tubes. Instant External Connections to 1,000 psi.

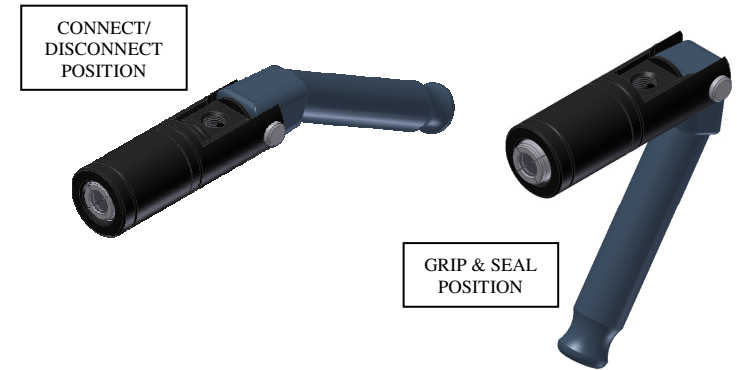

NuLaws JXL Connectors provide a reliable leak-tight connection that grips and seals straight tubing. Simply place the JXL connector onto a tube, activate the mechanical gripping and sealing action, then introduce the test media. For vacuum to 1000 psi applications with air, gas or liquid, **FasTest NuLaws** JXL Connectors provide secure, leak tight sealing.

Please thoroughly read and understand each of the following four steps before operating the connector. The use of pressurized media for sealing, testing and filling requires a thorough understanding of the **FasTest** JXL Installation and Operating Instructions.

- Operating Instructions
- Dimensional Information
- Collet Set and Main Seal Removal and Installations
- Safety-General Guidelines

- The connector is designed to mate with a specific application. Verify the application prior to the introduction of pressure or processing.
- Use only in a safe environment.
- Connectors are NOT designed for permanent connections and are for temporary connections only.
- Maximum rated test pressure for standard JXL models is 1000 psi. DO NOT EXCEED pressure rating as marked on connector or corresponding literature. Consult your **FasTest** representative with other requirements.