

GTEK AUTOMATION

A Division of Pacific Air Engineering, Inc.

GTR300-2.5X14

Reservoir Cartridge, 2.5" O.D. x 14" Long, Double Screen, 1/4" Ports

TECHNICAL DATA:

Material: FDA Approved Polypropylene.

Max. Working Pressure: 125 PSI.

Max. Working Temperature: 100 F.

Filtration: 50 Mesh Screens, Both Ends.

Volume: 45.71 Cubic Inches (749 ML).

* Volume Tolerance: +/- 1 Cubic Inches (16.4 ML)

SLIDE MOUNTING BRACKET ONTO THIS END →

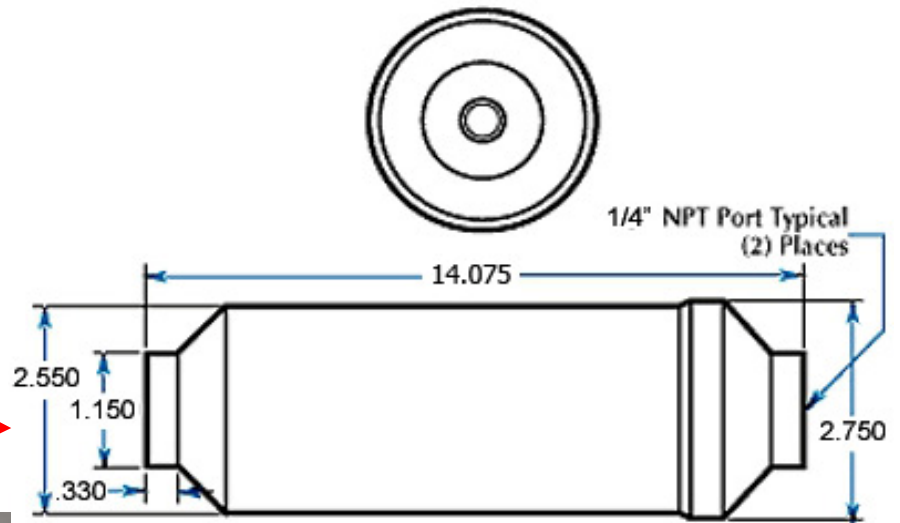

Mounting Bracket:

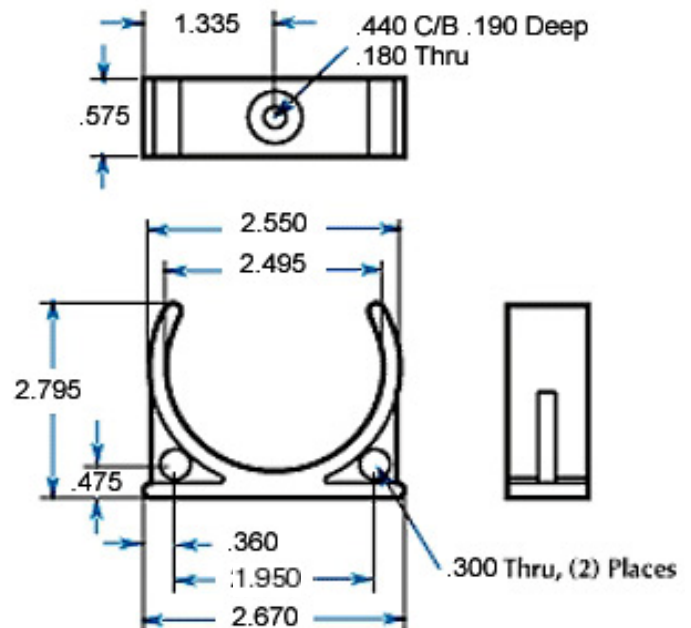

GTEK AUTOMATION

A Division of Pacific Air Engineering, Inc.

26212 Dimension Drive, Suite 150, Lake Forest, CA 92630

Ph. 949-680-4242, Fax. 949-680-4243, Email: Sales@Gtek-Automation.com

Web Site: Gtek-Automation.com